

NASA TM X-639

CONFIDENTIAL

NASA TM X-639

10005 copy 467

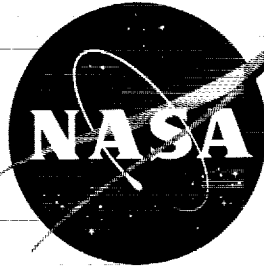

*0763-12564
code-1*

TECHNICAL MEMORANDUM

X-639

LANDING LOADS AND DYNAMICS OF THE X-15 AIRPLANE

By James M. McKay and Eldon E. Kordes

Flight Research Center
Edwards, Calif.

OTS PRICE

~~XXXXXXXXXX~~
~~XXXXXXXXXX~~

\$

\$

XEROX

MICROFILM

CLASSIFICATION CHANGED TO
UNCLASSIFIED
AUTHORITY NASA LIST #1, Dec 1, 1962
By *[Signature]*

CLASSIFIED DOCUMENT - TITLE UNCLASSIFIED

This material contains information affecting the national defense of the United States within the meaning of the espionage laws, Title 18, U.S.C., Secs. 793 and 794, the transmission or revelation of which in any manner to an unauthorized person is prohibited by law.

NATIONAL AERONAUTICS AND SPACE ADMINISTRATION

WASHINGTON

March 1962

CONFIDENTIAL



Good!

COPY # 2

UNCLASSIFIED

CONFIDENTIAL

NATIONAL AERONAUTICS AND SPACE ADMINISTRATION

TECHNICAL MEMORANDUM X-639

LANDING LOADS AND DYNAMICS OF THE X-15 AIRPLANE* **

By James M. McKay and Eldon E. Korde's

SUMMARY

This paper presents a discussion of the loads, accelerations, and displacements of the X-15 airplane and landing-gear system measured during landing impact. The measured quantities are related to the initial touchdown conditions and are compared with data from a theoretical analysis. The applicability of the analysis to the X-15 landing gear has been investigated for the gear in the absence of drag loads. Studies have also been made to determine the effects of variations in such parameters as elevator positions, skid coefficient of friction, main-gear location, and initial touchdown conditions beyond the range of the experimental data.

INTRODUCTION

One of the major problems that must be considered in the design of glide reentry vehicles is the provision for a safe landing on return. Landing-gear systems for these vehicles must meet all the usual requirements and, in addition, must be able to withstand the temperatures resulting from reentry. Also if adequate ground steering is not provided, the landing-gear system must give good stability during the runout. The X-15 marks the beginning of a class of reentry vehicles with a landing gear that is designed to meet these requirements. The X-15 landing-gear system consists of a main gear with steel skids placed well back on the fuselage, along with a conventional, nonsteerable nose gear placed well forward.

Because the landing-gear configuration represents a marked departure from previously used configurations, this paper reports on the landing loads experience of the X-15. A further purpose of the paper is to

*This document is based on a paper presented at the Conference on the Progress of the X-15 Project, Edwards Air Force Base, Calif., November 20-21, 1961. An appendix has been added to show the analytical relations used in an analog study of X-15 landing response.

**Title, Unclassified.

CONFIDENTIAL

review the dynamics of landing and to present results of a recent analytical study of the effects of various parameters on the landing loads. The landing flare maneuver and some of the slideout characteristics are covered in reference 1.

SYMBOLS

- \bar{c} mean aerodynamic chord, ft
- C_{L0} basic lift coefficient, $\frac{\text{Lift}}{qS}$
- $C_{L\alpha}$ lift-curve slope, per radian
- C_{m0} basic pitching-moment coefficient, $\frac{\text{Pitching moment}}{qS}$
- $C_{m\delta_h}$ horizontal-tail-effectiveness parameter, per deg
- $C_{m\dot{\theta}} = \frac{\partial C_m}{\partial \left(\frac{\dot{\theta} \bar{c}}{2V} \right)}$
- F_{ma} vertical ground reaction due to pneumatic force in main-gear shock strut, lb
- F_{mb} vertical ground reaction due to bending of main-landing-gear strut, lb
- F_{mh} vertical ground reaction due to hydraulic force in main-gear shock strut, lb
- F_{na} pneumatic forces in nose-gear shock strut, lb
- F_{nh} hydraulic force in nose-gear shock strut, lb
- F_{nt} vertical force, applied to nose-gear tire at ground, lb
- F_t horizontal-tail aerodynamic load, lb
- F_v vertical ground reaction, lb
- g acceleration due to gravity, ft/sec²
- I_y moment of inertia about Y-axis, slug-ft²

- L lifting force, lb
- L_{cg} vertical distance from airplane center of gravity to ground, ft
- L_h horizontal distance from airplane center of gravity to point of contact of landing gear with ground, ft
- L_v vertical distance from fuselage reference to point of landing-gear contact with ground at landing-gear location, ft
- m mass, W/g
- q dynamic pressure, lb/sq ft
- S wing area, sq ft
- V free-stream velocity, ft/sec
- V_{v0} airplane sinking speed at initial touchdown, ft/sec
- W airplane landing weight, lb
- W_n weight of nose-gear lower mass below shock strut, lb
- α angle of attack, deg
- α_0 initial angle of attack at touchdown, deg
- γ angle between pitch-attitude angle and angle of attack, deg
- δ vertical displacement of upper mass from position at initial contact, ft
- δ_h horizontal-tail deflection, deg
- δ_t vertical displacement of nose-gear lower mass from position at initial contact, ft
- θ pitch attitude, deg
- $\dot{\theta}$ pitching velocity, radians/sec
- μ coefficient of friction

Subscripts:

- m main gear
- n nose gear

A dot over a symbol indicates the derivative of the quantity with respect to time.

A double dot over a symbol indicates a second derivative of the quantity with respect to time.

GENERAL DESCRIPTION

Because of the airplane configuration, the landing characteristics of the X-15 are somewhat unusual. A typical landing sequence is illustrated in figure 1. The sketch at the top of the figure shows that a nose-high attitude is established just prior to main-gear touchdown. The airplane weight, wing lift, and tail loads are indicated by the arrows in each sketch, and the springs represent both the main and nose landing gear. During main-gear contact, the airplane rotates and impacts on the nose gear, as shown in the second sketch. During nose-gear compression, a second reaction occurs on the main gear, as indicated in the third sketch. It is significant to mention that this second reaction is far greater than the first, as will be shown subsequently. The airplane then rests on both gears for the slideout, as shown in the bottom sketch.

Thus far, 45 landings have been made with the X-15. The first four pointed out certain deficiencies in gear design. The principal deficiency can be brought out by reference to figure 2, which shows one of the main gears of the X-15 and also serves to indicate the unusual nature of the gear operation. The gear consists of a steel skid and an Inconel X strut which is attached to the fuselage by trunnion fittings and through bell-crank arms to shock struts inside the fuselage. The skids are free in pitch and roll, but are fixed for parallel alignment. Drag braces are attached to the fuselage ahead of the trunnion fitting and to the skid at the strut-attachment pin. The bungee springs are used to keep a nose-up position of the skids just before landing. During flight the skids and landing-gear struts are folded forward against the outside of the fuselage. After release, they are extended simply by gravity and air loads.

The main changes that were made in this main-gear arrangement were simply to replace the shock struts by struts having greater energy-absorbing characteristics and to "beef up" the gear back-up structure somewhat. These changes were brought about mainly because the gross weight of the airplane had increased and also because the down-load on the elevator during landing was found to be greater than that taken into account in design.

In connection with this discussion, the fourth X-15 landing, which was an emergency landing made after an engine explosion, should be

mentioned. It is significant to note that the failure of the fuselage during this landing was not attributed to a design error; rather, it occurred because the airplane landed in an overweight condition, since all the fuel could not be jettisoned, and because of a high nose-gear load, caused by foaming of the gas and oil mixture in the shock strut. A permanent solution to the foaming problem was achieved by using a free-floating piston inside the strut to separate the gas and oil. With these main changes, the last 41 landings have been without major incident.

EXPERIMENTAL RESULTS

Main-Gear Response

During the X-15 program, the airplane has been instrumented to measure gear loads, gear travel, and accelerations. Figure 3 shows the main-gear shock-strut force and travel measured on a typical landing. The upper curve is the strut travel and the lower curve is the strut force, measured from time after main-gear touchdown. At touchdown, the angle of attack α_0 was 8° , the sinking speed V_{V0} was 3 feet per second, and the landing weight W was 14,500 pounds. The sketches at the top of this figure are used to aid in identifying the landing sequence. It is important to note that both the shock-strut force and travel are appreciably higher during the second reaction on the main gear following the nose-gear touchdown than during the initial portion of the landing. These high values are due to several factors, primarily to the main-gear location well back of the airplane center of gravity and to the pronounced aerodynamic load on the tail, the negative wing lift during this portion of the landing, and the airplane inertia loads. The increasing air load on the tail is brought about by two sizable increases in angle of attack, namely, the rotation of the airplane onto the nose gear, and a change in the wind-flow direction to nearly horizontal due to arresting the vertical descent. Experience with the X-15 has shown that the horizontal-tail angle, and hence the tail loads are also increased by the stability augmentation system as the airplane pitches down. The time history of only one gear is shown since all landings have been nearly symmetrical and both skids have been solidly on the lakebed before nose-gear touchdown occurred.

The influence of airplane sinking speed on main-gear response for many landings with the modified gear system is shown in figure 4. Airplane vertical travel at the main gear, and shock-strut force for the first- and second-peak values are presented in terms of airplane sinking speed at initial touchdown. Values measured at the first peak are shown by circles and at the second peak by squares. These data are for angles of attack between 4° and 11° , and ground speeds at touchdown between 145 and 238 knots. Note that there is good correlation between sinking

speed and the measured quantities at the first peak. It is important to point out that the values at the second peak are independent of sinking speed. It should be noted also that as the sinking speed increases, the values at the first peak approach those of the second. No definite correlation for the first peak has been found between vertical travel or shock-strut force and angle of attack or forward speed at touchdown.

Nose-Gear Response

The influence of airplane sinking speed on nose-gear response is shown in figure 5. Nose-gear contact velocity, shock-strut travel, and vertical reaction are presented for various airplane sinking speeds. The results indicate that there is little change in the measured quantities with airplane sinking speed. The large magnitudes of the quantities are, of course, due to the rapid rotation of the airplane after the initial touchdown. The loads resulting from the high nose-gear contact velocities cause high but acceptable accelerations on the pilot during this phase of the landing. However, the lack of any indicated trend with initial sinking speed is probably due to the absorption by the main gear of a larger portion of the total energy during the first peak at the higher airplane sinking speeds.

Analytical Results

Experience during the program has shown that the pilots tend to land the X-15 in a similar way on each flight. Therefore, the effect of many of the variables cannot be determined from the experimental data. In order to study some of the conditions that affect the gear response, an analytical study has been conducted (see appendix). Results from the calculations are compared with X-15 data in figure 6, where the time history of the main-gear-skid vertical reaction is shown for a typical landing. The initial conditions are angle of attack α_0 of 8° , airplane sinking speed V_{V_0} of 3 feet per second, and airplane landing weight W of 14,500 pounds. The method used for obtaining the skid reaction from data of an actual landing necessarily resulted in faired values, as indicated by the solid line. The dashed curve is used to show the calculated values. Although there is a slight time difference at the second peak, the magnitudes of the maximum first and second reactions agree extremely well. The good agreement between calculated and measured results gives confidence in the ability of the analysis to determine the X-15 landing response.

Horizontal-Tail Load

The downward-acting horizontal-tail load during landing is large and has a marked influence on the vertical reaction on the main-gear skid. The results of an analysis which calculated its effects are shown in figure 7, in which skid vertical reaction is given as a function of airplane sinking speed for an initial angle of attack of 8° . The results, along with some experimental data, are shown for both the maximum first reaction and the maximum second reaction per skid. The dashed curves apply to the condition where the elevator position is held constant at -4° during the landing. The solid curves are for the condition brought about by the stability augmentation system, where the elevator position varies from the angle of trim of -4° at touchdown to -15° at nose-gear contact. The latter condition is one that usually exists for actual landings of the X-15 airplanes. The differences between the solid and dashed curves are due to the increased tail loads associated with the difference in elevator position. Note the large decrease in the magnitude of the second reaction obtained by keeping the elevator angle small. In fact, a greater reduction in load would be expected with the horizontal tail rotated to a positive angle, leading-edge up, at the instant of main-gear contact. These results show the desirability of including an automatic system to control the elevator positions after touchdown, and, hence, to reduce the second reaction on the main-gear system.

Skid Coefficient of Friction

Several different types of skids have been proposed for reentry-type vehicles, including wire-brush skids. One of the main differences in the skids is in the value of the skid coefficient of friction. The influence of the skid coefficient of friction on the landing response has been calculated and the results are shown in figure 8. The skid and the nose-gear vertical reaction are presented as a function of airplane sinking speed. The solid curve shows the results for a skid-friction coefficient μ of 0.33, which is representative of the skid on the X-15 airplane. The dashed curve is for a friction coefficient of 0.7, which is typical of the values for a wire-brush skid. The results indicate that increasing the coefficient of friction tends to reduce the vertical skid reaction slightly and, as might be expected, to increase the nose-gear vertical reaction. Even though the vertical reactions are not appreciably affected by increasing the coefficient of friction, the drag loads would be affected to a larger degree.

Main-Gear Location

Another factor that would be expected to affect the gear loads is the location of the main gear with respect to the airplane center of

gravity. The next results are intended only to show the effect of moving the main-gear location and should not be interpreted to imply any change to the X-15. This effect has been calculated by using X-15 parameters. The results of the calculations are shown in figure 9 for two positions of the main gear. The skid and nose-gear vertical reactions are shown again as a function of airplane sinking speed. The solid curve is for a gear distance L_{h_m} of 15.9 feet aft of the center of gravity, which is the value for the X-15; the dashed curve represents the results obtained by moving the gear to a position one-third of the distance to the center of gravity ($L_{h_m} = 11.3$ ft). The results indicate that the second reaction on the main gear is not affected to a great extent; however, the effect of moving the gear forward increases the first reaction in such a way that, at the higher sinking speeds, the values of the first and second reaction approach each other. The results do show that moving the main gear forward reduces the nose-gear vertical reaction. It can be seen that a change in the gear position to a little over 11 feet does not have as much effect as might be expected. However, other results not shown here indicate that if the gear is moved still closer to the center of gravity, there is an appreciable reduction in the second main reaction; thus, a configuration representing that of a present-day fighter aircraft is approached, wherein the first reaction is the one that is critical. The analytical program is being continued to study the effects of other parameters on the landing-gear requirements for reentry vehicles.

CONCLUSIONS

Landings with the X-15 airplane have shown that the main-gear loads, measured during the second reaction after nose-gear contact, are several times larger than the loads experienced during the initial phase of the landing. The large loads during the second main-gear reaction are attributed to the main-gear location as well as to the large tail loads, the negative wing lift, and the airplane inertial loads after nose-gear touchdown. The high nose-gear contact velocities due to the airplane pitching down result in high nose-gear loads, and, consequently, in high accelerations on the pilot during this phase of the landing. Calculated results are used to show that the main-gear reaction can be reduced by proper control of the elevator angle during touchdown. These results also show that increasing the skid coefficient of friction reduces the main-gear reaction slightly, but increases the nose-gear reaction. The calculated results also show that moving the main gear forward increases the first main-gear reaction but reduces the nose-gear reaction.

Flight Research Center
National Aeronautics and Space Administration
Edwards, Calif., November 20, 1961

APPENDIX

Analytical Relations Used in Analog Study of X-15 Landing Response

An analytical study was made to determine the effect of the X-15 landing response to such quantities as horizontal-tail loads, skid friction coefficients, gear location, and initial touchdown conditions. This analysis was conducted on an electric analog with four degrees of freedom; main-gear motion, nose-gear motion, airplane pitch, and vertical translation.

The program made use of the following relations to describe the motion of the airplane upper mass, which was considered to be rigid.

Airplane pitch:

$$\begin{aligned}
 I_Y \ddot{\theta} = & qS\bar{c} \left(C_{m0} + C_{m\delta_h} \delta_h + \frac{\bar{c}}{2V} C_{m\dot{\theta}} \dot{\theta} \right) \\
 & - F_{V_m} \left[2\theta \left(\mu_m L_{h_m} - L_{V_m} \right) + 2 \left(L_{h_m} + \mu_m L_{V_m} \right) \right] \\
 & + F_{V_n} \left[\theta \left(L_{V_n} + \mu_n L_{h_n} \right) + \left(L_{h_n} - \mu_n L_{V_n} \right) \right]
 \end{aligned}$$

Vertical translation:

$$\dot{\gamma}_m V = qS \left(C_{L0} + C_{L\alpha} \alpha \right) + \left(F_{V_n} + 2F_{V_m} - W \right) \cos \gamma$$

For the main-gear-skid vertical reaction, the following relations were used:

Before the upper-mass displacement began

$$F_{V_m} = F_{m_b}$$

After the upper-mass displacement began

$$F_{V_m} = F_{m_a} + F_{m_h}$$

and

$$\dot{\delta}_m = -\dot{L}_{cg} + \dot{\theta} L_{h_m}$$

Relations used for the nose-gear vertical reaction were as follows:

Before the beginning of shock-strut deflection

$$F_{v_n} = F_{n_t}$$

The equation of motion used for the nose-gear lower mass was

$$W_n + (F_{v_n} - F_{n_t}) - \frac{W_n}{g} \ddot{\delta}_t = 0$$

After the beginning of shock-strut deflection

$$F_{v_n} = F_{n_a} + F_{n_h}$$

and

$$\dot{\delta}_n = -\dot{L}_{cg} - \dot{\theta}L_{n_n}$$

December 21, 1961

CONFIDENTIAL

CONFIDENTIAL

11

REFERENCES

1. White, Robert M., Robinson, Glenn H., and Matranga, Gene J.: Résumé of Handling Qualities of the X-15 Airplane. NASA TM X-715, 1962.

CONFIDENTIAL

X-15 TOUCHDOWN SEQUENCE

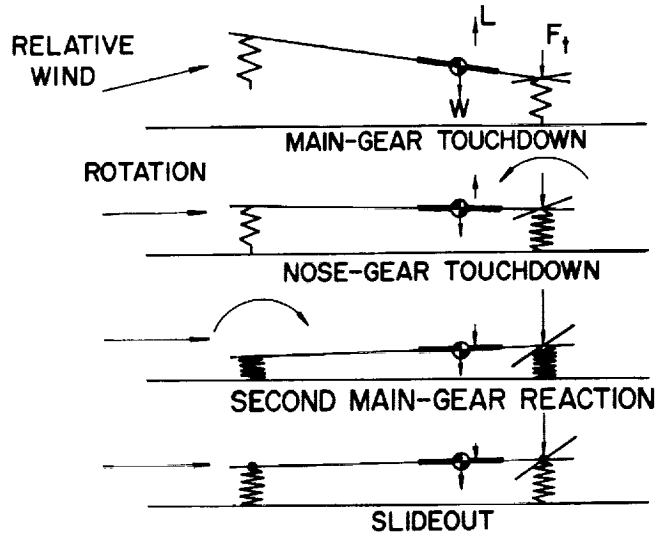

Figure 1

X-15 MAIN LANDING GEAR

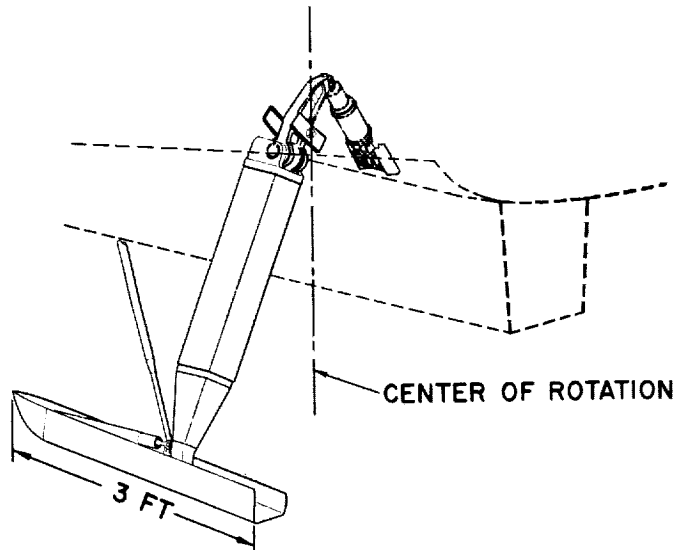

Figure 2

MAIN-GEAR SHOCK-STRUT FORCE AND TRAVEL

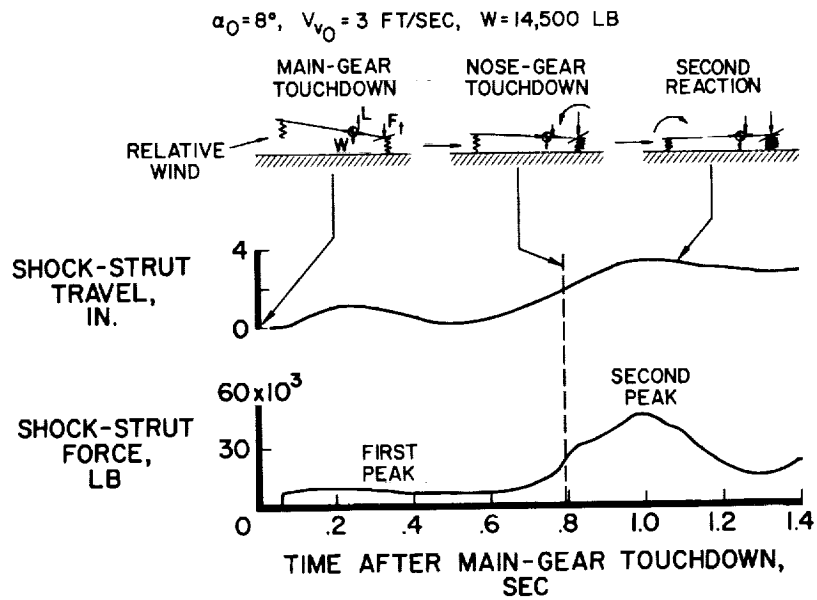

Figure 3

INFLUENCE OF AIRPLANE SINK SPEED ON MAIN-GEAR RESPONSE

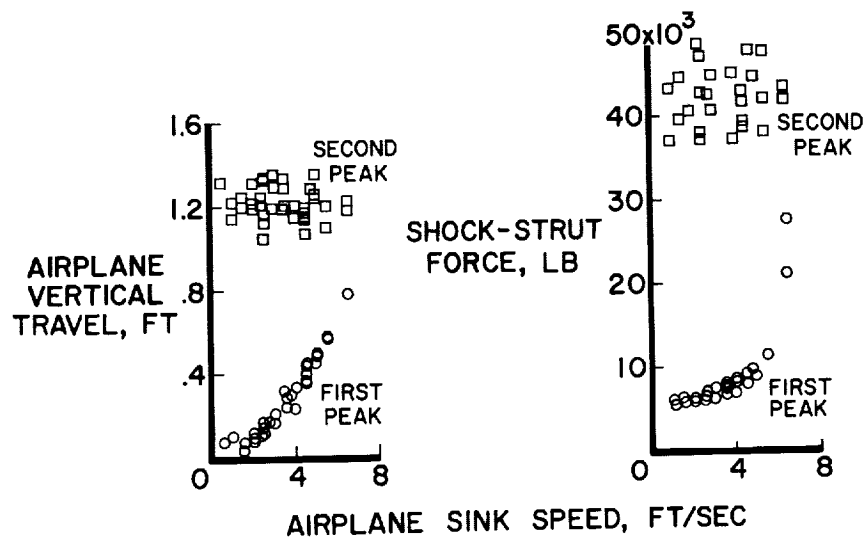

Figure 4

INFLUENCE OF AIRPLANE SINK SPEED ON NOSE-GEAR RESPONSE

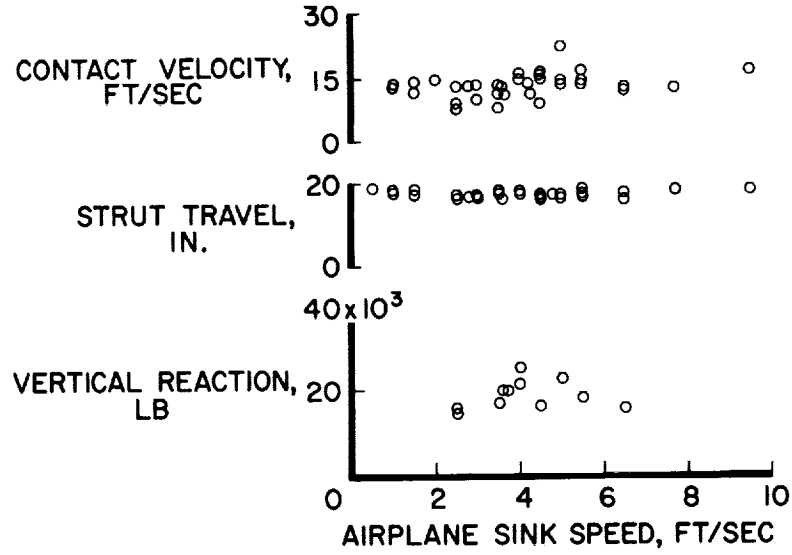

Figure 5

MAIN-GEAR-SKID VERTICAL REACTION

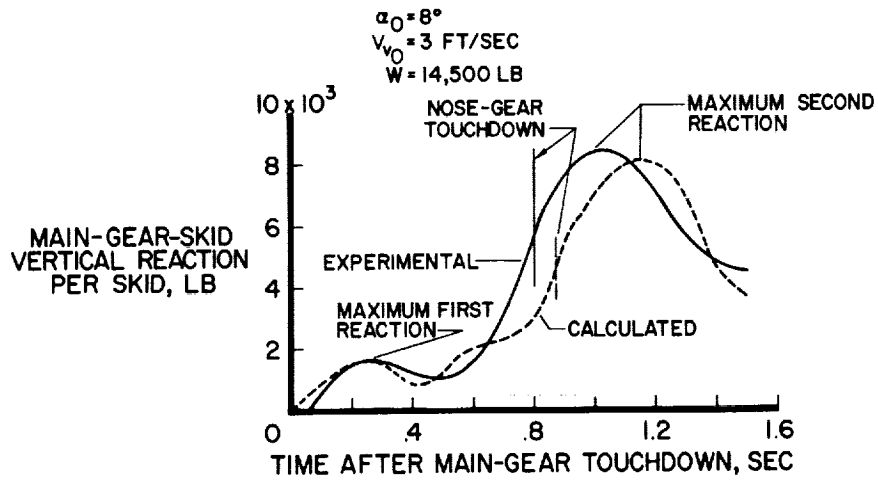

Figure 6

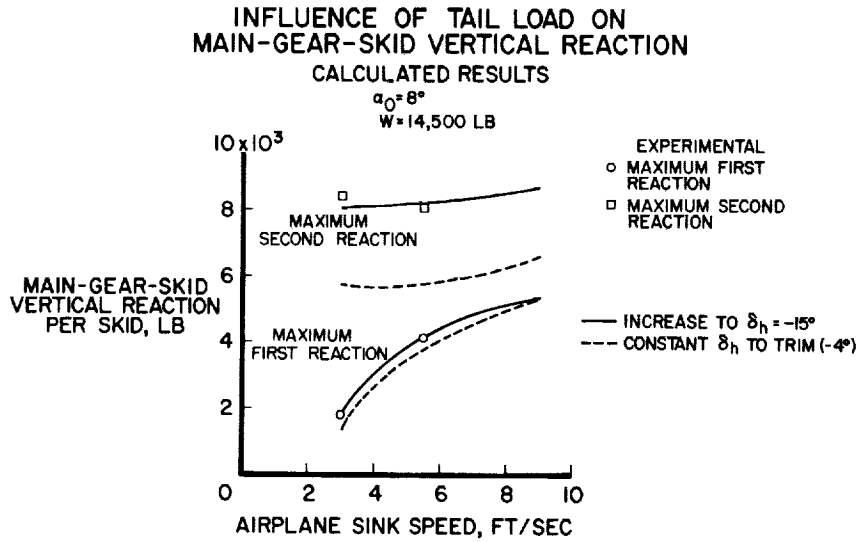

Figure 7

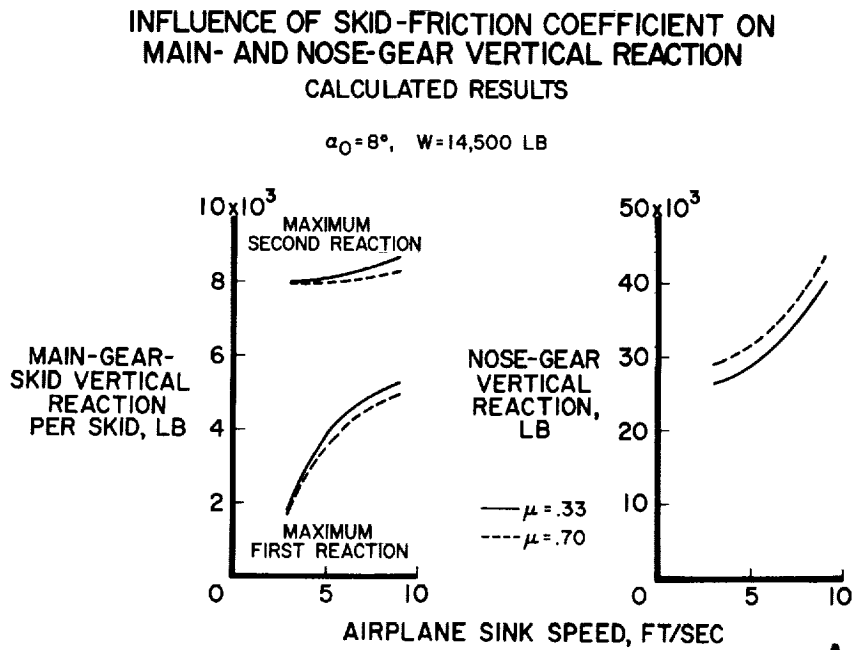

Figure 8

INFLUENCE OF MAIN-GEAR LOCATION ON
MAIN- AND NOSE-GEAR VERTICAL REACTION
CALCULATED RESULTS

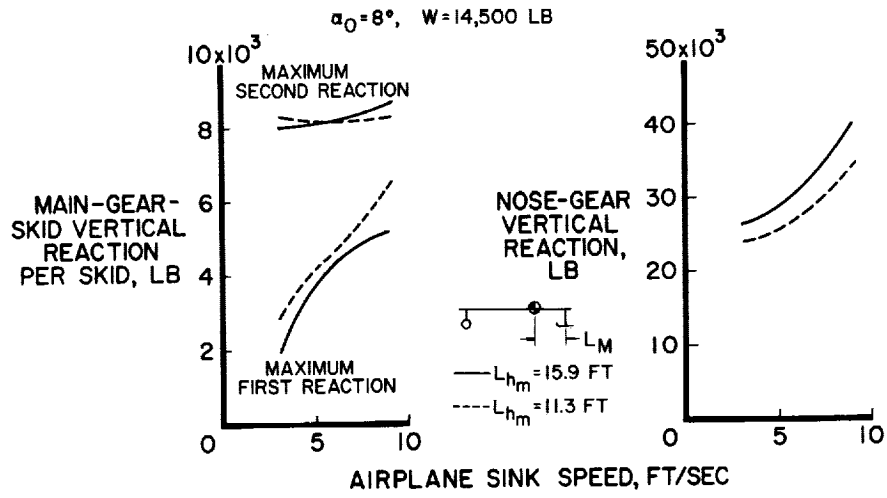

Figure 9